

# PLCC 3528 0.06W Single Color Datasheet



## Features :

- High luminous Intensity and high efficiency
- Based on Blue/Green : InGaN, Red : AlGaInP technology
- Wide viewing angle : 120°
- Excellent performance and visibility
- Suitable for all SMT assembly methods
- IR reflow process compatible
- Environmental friendly; RoHS compliance

## Typical Applications :

- Signal and Symbol Luminaire
- Indoor and Outdoor Displays
- Backlighting (illuminated advertising, general lighting)
- Interior Automotive Lighting

## Table of Contents

---

General Information .....	3
Absolute Maximum Ratings .....	4
Characteristics .....	4
Luminous Intensity Characteristic.....	5
Voltage Bin Structure .....	6
Wavelength Bin Structure .....	6
Mechanical Dimensions.....	7
Characteristic Curve .....	8
Reflow Profile .....	11
Reliability.....	12
Product Packaging Information .....	13
Revision History .....	14
About Edison Opto .....	14

## General Information

### Introduction

Ultra high luminous efficacy, combined with the flexibility in design due to its slim and miniature size, PLCC LED Series are optimized to be used as lighting for signboard.

### Ordering Code Format

$\frac{2}{X1}$      $\frac{T}{X2}$      $\frac{03}{X3-X4}$      $\frac{Y6}{X5-X6}$      $\frac{XX}{X7-X8}$      $\frac{XX}{X9-X10}$      $\frac{000}{X11-X13}$      $\frac{XXX}{X14-X16}$

X1		X2		X3-X4		X5-X6		X7-X8	
Type		Component		Series		Wattage		Color	
2	Emitter	T	PLCC	03	3528	Y6	0.06W	RX	Red
								TX	True Green
								BX	Blue
								AX	Amber
								YX	Yellow

X9-X10		X11-X13		X14-X16	
Internal code		PCB Board		Serial Number	
-	-	000	-	-	-

## Absolute Maximum Ratings

Absolute maximum ratings ( $T_a=25^{\circ}\text{C}$ )

Parameter	Symbol	Value	Units
Forward Current	$I_F$	R/A/Y : 35 T/B : 30	mA
Pulse Forward Current ( $t_p \leq 100\mu\text{s}$ , Duty cycle=0.25)	$I_{\text{pulse}}$	R/A/Y : 80 T/B : 100	mA
Reverse Current	$I_R$	10	$\mu\text{A}$
Reverse Voltage	$V_R$	5	V
LED Junction Temperature	$T_J$	115	$^{\circ}\text{C}$
Operating Temperature	-	-40 ~ +85	$^{\circ}\text{C}$
Storage Temperature	-	-40 ~ +125	$^{\circ}\text{C}$
ESD Sensitivity (HBM)	$V_B$	2,000	V
Soldering Temperature	$T_s$	Reflow Soldering : 255~260 $^{\circ}\text{C}$ /10~30sec Manual Soldering : 350 $^{\circ}\text{C}$ /3sec	

Notes:

1. Proper current derating must be observed to maintain junction temperature below the maximum at all time.
2. LEDs are not designed to be driven in reverse bias.
3.  $t_p$ : Pulse width time

## Characteristics

Parameter	Symbol	Value	Units
Viewing Angle (Typ.)	$2\theta_{1/2}$	120	Degree
Forward voltage (Typ.)	$V_F$	R/A/Y : 2.2 T/B : 3.2	V
Thermal resistance	$R_{j_s}$	180	$^{\circ}\text{C}/\text{W}$
Wavelength	(Red) (Amber) (Yellow) (True Green) (Blue)	620-630 610-620 585-595 520-535 465-475	nm
JEDEC Moisture Sensitivity	-	Level 2a <b>Floor Life</b> Conditions: $\leq 30^{\circ}\text{C}$ / 60% RH <b>Soak Requirements(Standard)</b> Time (hours): 120+1/-0 Conditions: 60 $^{\circ}\text{C}$ / 60% RH	-

Note:

$2\theta_{1/2}$  is the off-axis angle where the luminous intensity is half of the axial luminous intensity.

## Luminous Intensity Characteristic

Luminous Intensity Characteristics,  $I_f=20\text{mA}$  and  $T_j=25^\circ\text{C}$ .

Color	Group	Min. Luminous Intensity (mcd)@20mA	Max. Luminous Intensity (mcd)@20mA	Order Code
Red	B0	400	500	2T03Y6RX00000002
	B1	500	600	
	B2	600	700	
	C0	700	850	
	C1	850	1000	
	C2	1000	1150	
Amber	C0	700	850	2T03Y6AX00000002
	C1	850	1000	
	C2	1000	1150	
	C3	1150	1300	
Yellow	B1	500	600	2T03Y6YX00000002
	B2	600	700	
	C0	700	850	
	C1	850	1000	
	C2	1000	1150	
	C3	1150	1300	
Green	C2	1000	1150	2T03Y6TX00000002
	C3	1150	1300	
	C4	1300	1450	
	C5	1450	1600	
	C6	1600	1750	
	C7	1750	1900	
	D0	1900	2150	
Blue	A5	250	300	2T03Y6BX00000002
	A6	300	350	
	A7	350	400	
	B0	400	500	
	B1	500	600	
	B2	600	700	

**Note:**

The luminous intensity performance is guaranteed within published operating conditions. Edison Opto maintains a tolerance of  $\pm 10\%$  on intensity measurements.

## Voltage Bin Structure

Group	Min. Voltage (V)	Max. Voltage (V)
U03	1.6	1.9
U04	1.9	2.2
U05	2.2	2.5
V00	2.5	2.8
V01	2.8	3.1
V02	3.1	3.4
V03	3.4	3.7
V04	3.7	4.0

Note:  
Forward voltage measurement allowance is  $\pm 0.06V$ .

## Wavelength Bin Structure

Color	Group	Min. Wd (nm)	Max. Wd (nm)
Red	RX0	620	630
Amber	OX1	610	615
	OX2	615	620
Yellow	YW0	585	588
	YX0	588	591
	YY0	591	595
Green	TW0	520	525
	TX0	525	530
	TY0	530	535
Blue	BW0	460	465
	BX0	465	470
	BY0	470	475

Note:  
Dominant wavelength Measurement Allowance is  $\pm 1nm$

## Mechanical Dimensions

### Emitter Type Dimension

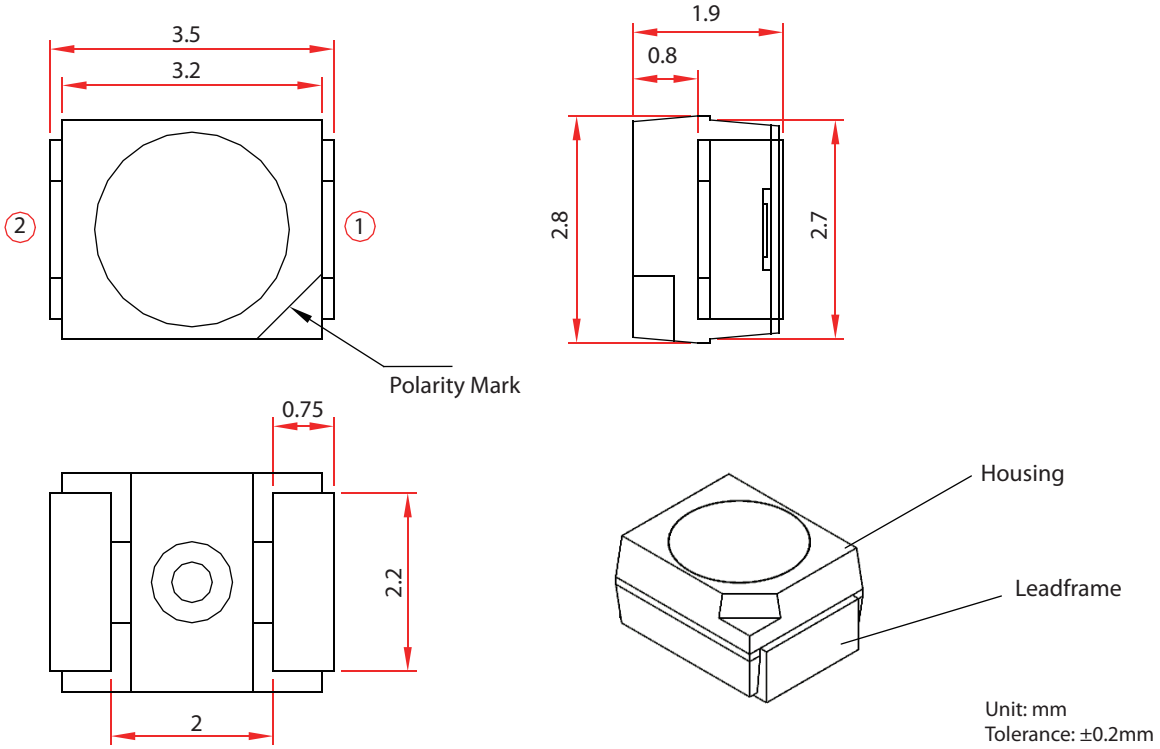

### Circuit

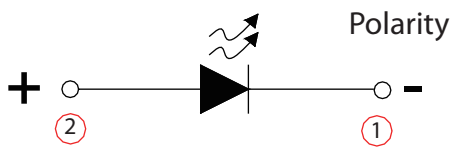

### Solder Pad

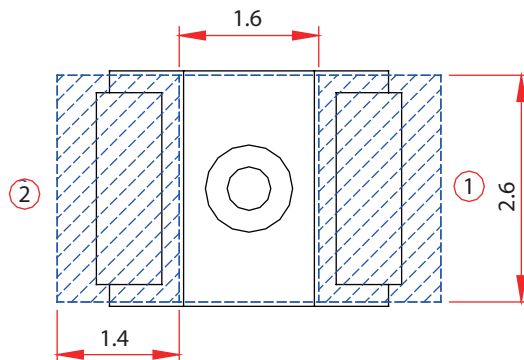

- Notes:
1. All dimensions are measured in mm.
  2. Tolerance :  $\pm 0.2\text{ mm}$

## Characteristic Curve

### Color Spectrum

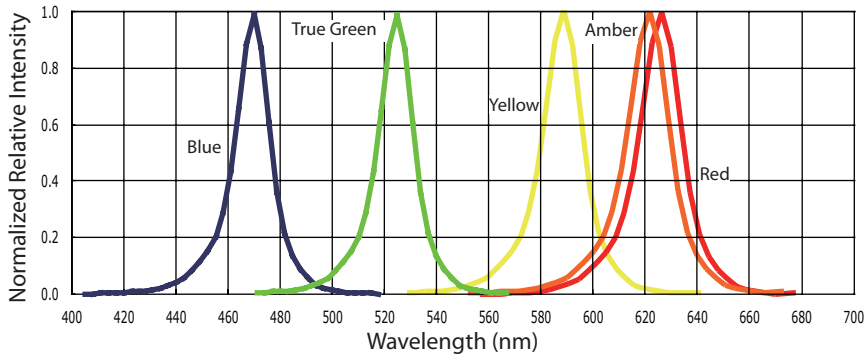

Color Spectrum at a typical CCT

### Beam Pattern

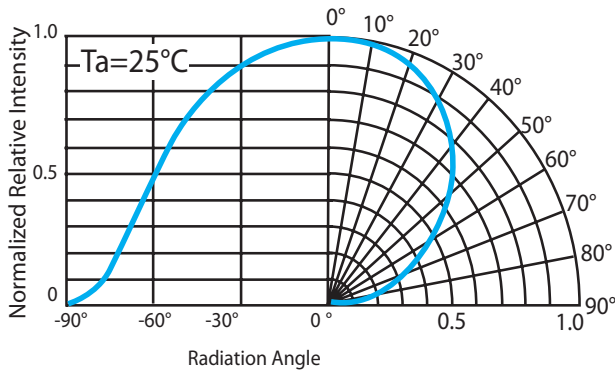

Beam pattern diagram for PLCC 3528 series

### Forward Voltage vs. Forward Current

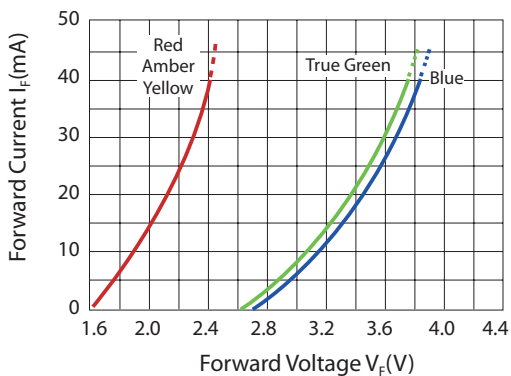

Forward current vs. forward voltage for PLCC 3528 series

### Luminous Flux vs. Forward Current

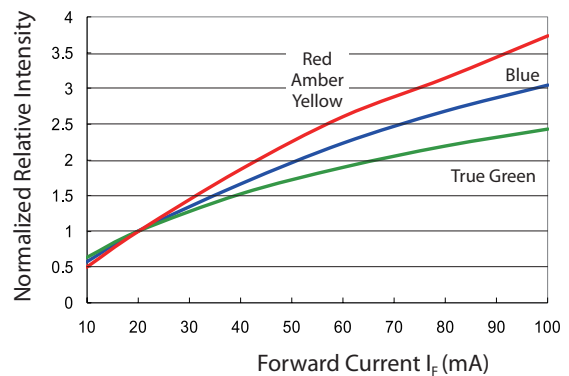

Forward current vs. relative luminous at  $T_a=25^\circ\text{C}$  for PLCC 3528 series



### Forward Voltage vs. Junction Temperature

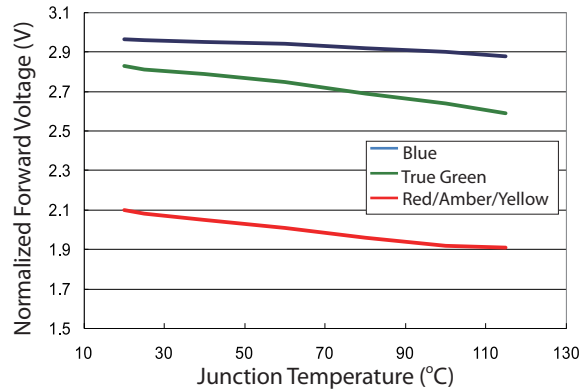

Forward voltage vs. Junction temperature for PLCC series

### Luminous Flux vs. Junction Temperature

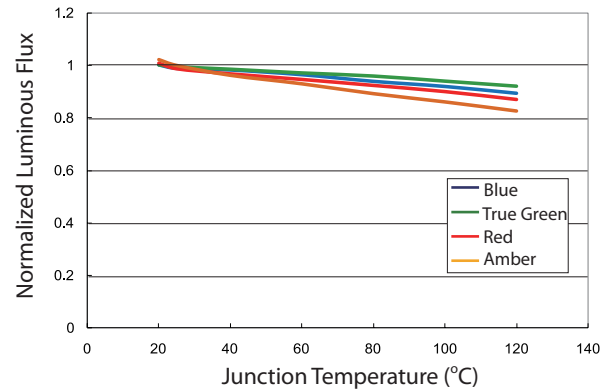

Forward current vs. luminous flux for PLCC series

### Wavelength vs. Forward Current

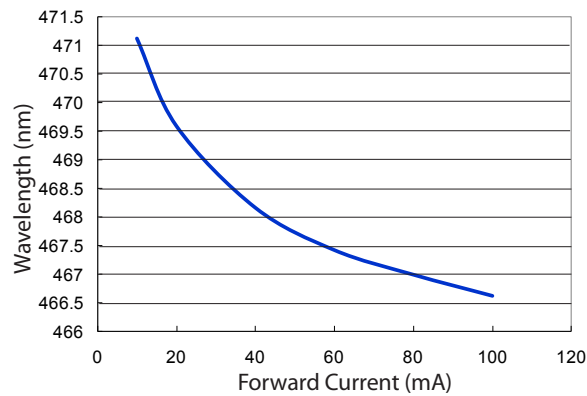

Wavelength vs. forward current for PLCC Blue

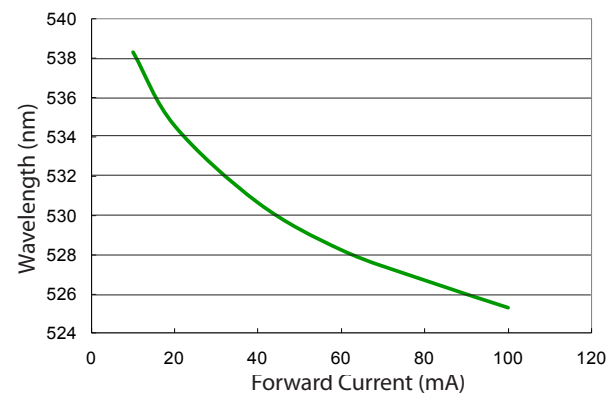

Wavelength vs. forward current for PLCC True Green

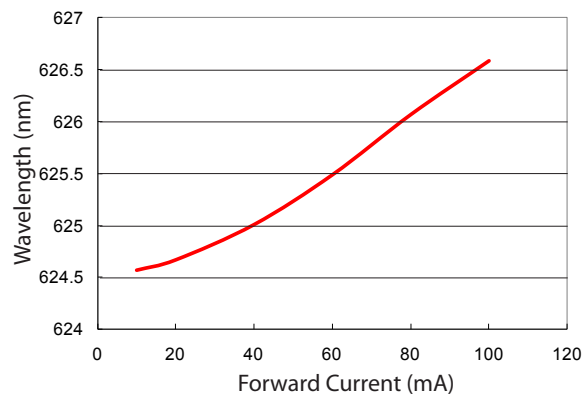

Wavelength vs. forward current for PLCC Red, Amber, Yellow

### Wavelength vs. Junction Temperature

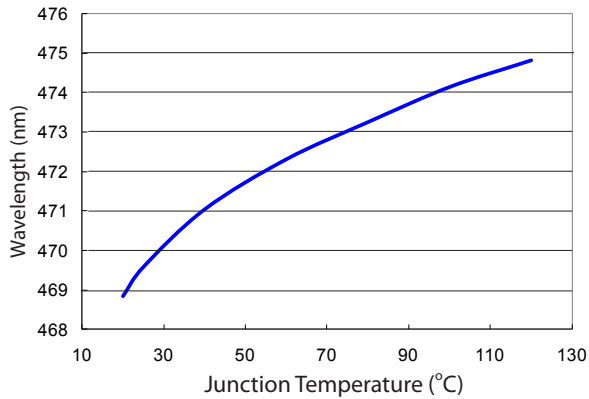

Wavelength vs. Junction temperature for PLCC Blue

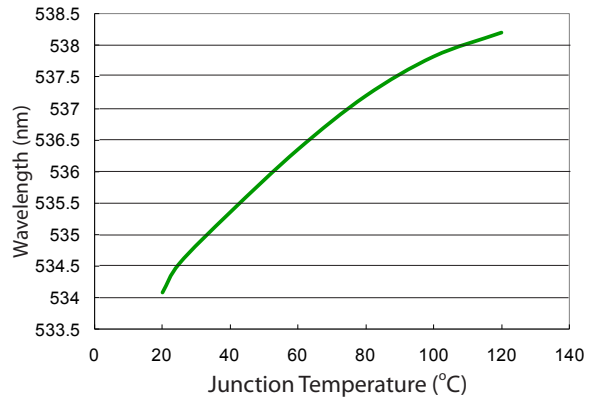

Forward current vs. luminous flux for PLCC True Green

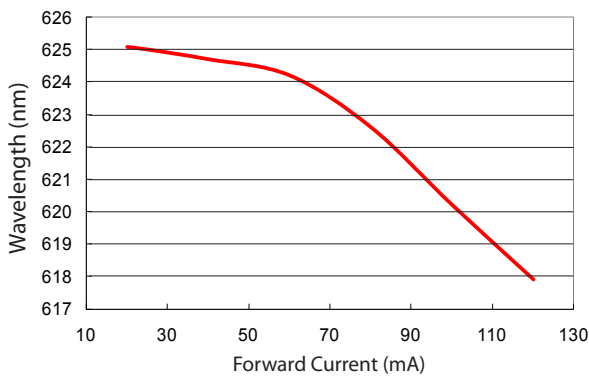

Wavelength length vs. forward current for PLCC Red & Yellow

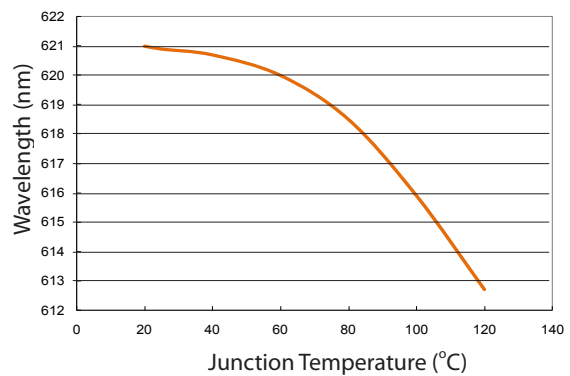

Forward current vs. luminous flux for PLCC Amber

### Forward Current vs. Ambient Temperature

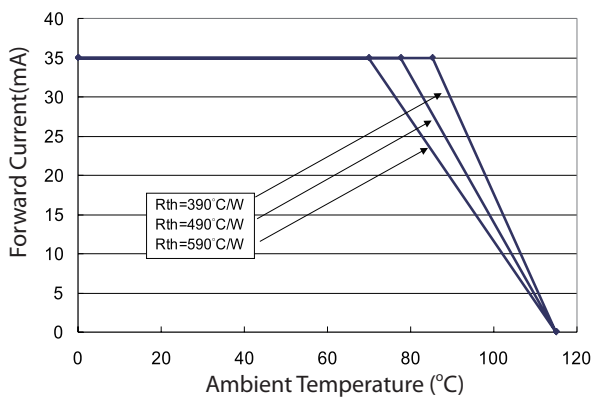

Forward Current vs. Ambient temperature for PLCC Red, Amber, Yellow

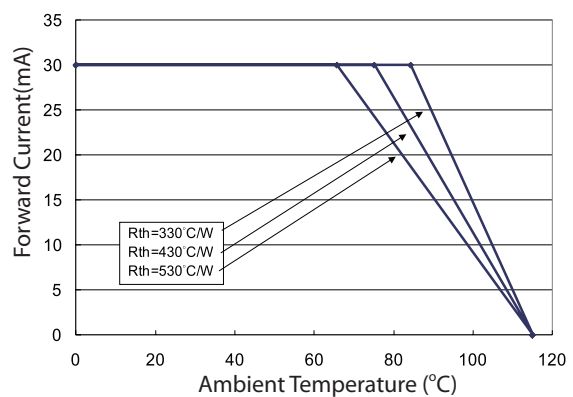

Forward Current vs. Ambient temperature for PLCC True Green, Blue

## Reflow Profile

The following reflow profile is from IPC/JEDEC J-STD-020D which provided here for reference.

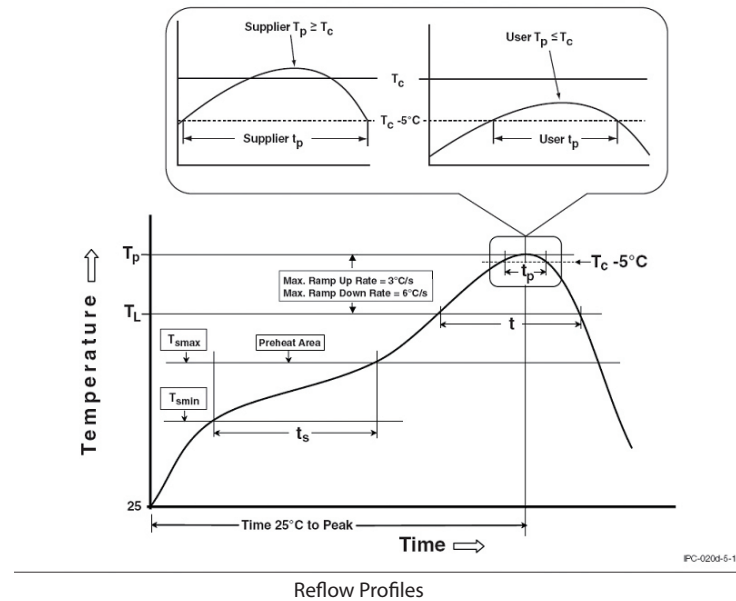

## Classification Reflow Profiles

Profile Feature	Pb-Free Assembly
Preheat & Soak	
Temperature min ( $T_{smin}$ )	150 °C
Temperature max ( $T_{smx}$ )	200 °C
Time ( $T_{smin}$ to $T_{smx}$ ) (ts)	60-120 seconds
Average ramp-up rate ( $T_{smx}$ to $T_p$ )	3 °C/second max.
Liquidous temperature ( $T_L$ )	217 °C
Time at liquidous ( $t_L$ )	60-150 seconds
Peak package body temperature ( $T_p$ )*	255 °C ~260 °C *
Classification temperature ( $T_c$ )	260 °C
Time ( $t_p$ )** within 5 °C of the specified classification temperature ( $T_c$ )	30** seconds
Average ramp-down rate ( $T_p$ to $T_{smx}$ )	6°C/second max.
Time 25°C to peak temperature	8 minutes max.

Notes:

- \* Tolerance for peak profile temperature ( $T_p$ ) is defined as a supplier minimum and a user maximum.
- \*\* Tolerance for time at peak profile temperature ( $t_p$ ) is defined as a supplier minimum and a user maximum.

## Reliability

NO .	Test Item	Test Condition	Remark
1	Temperature Cycle	-40°C~100°C 30, 30, mins	100 Cycle
2	Thermal Shock	-40°C~100°C 15, 15 mins ≤ 10 sec	100 Cycle
3	Resistance to Soldering Heat	T <sub>SOL</sub> =260°C, 30 sec	3 times
4	Moisture Resistance	25°C~65°C 90% RH 24 hrs / 1 cycle	10 Cycle
5	High-Temperature Storage	T <sub>A</sub> =100°C	1,000 hrs
6	Humidity Heat Storage	T <sub>A</sub> =85°C RH=85%	1,000 hrs
7	Low-Temperature Storage	T <sub>A</sub> =-40°C	1,000 hrs
8	Operation Life test	25°C	1,000 hrs
9	High Temperature Operation Life test	85°C	1,000 hrs
10	High Humidity Heat Life Test	85°C, 85%RH	1,000 hrs
11	ON/OFF Test	30 sec ON, 30 sec OFF	1.5W times

## Failure Criteria

Item	Criteria for Judgment	
	Min.	Max.
Lumen Maintenance	85%	-
$\Delta u'v'$	-	0.006
Forward Voltage	-	Initial Data x 1.1
Reverse Current	-	10 $\mu$ A
Resistance to Soldering Heat	No dead lamps or visual damage	

## Product Packaging Information

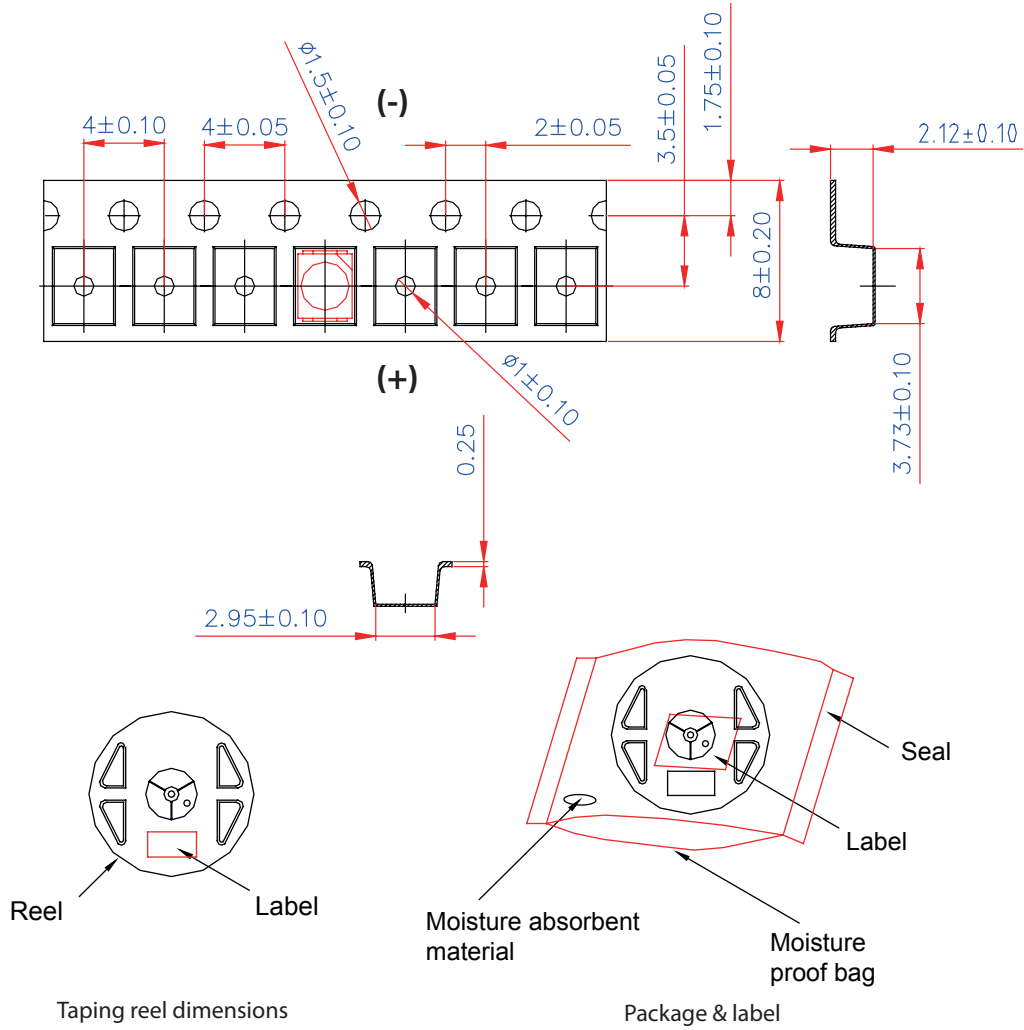

Item	Quantity	Total	Dimensions(mm)
Reel	2,000pcs	2,000pcs	R=178
Box	5 Reels	10,000pcs	240*235*67
Carton	5 boxes	50,000pcs	353*254*256

Starting with 50pcs empty, and 50pcs empty at the last

## Revision History

Versions	Description	Release Date
1	Establish order code information	2013/01/04
2	1. Add the Characteristic curve 2. Luminous Intensity Characteristic : Add Bin Group (Red)	2013/10/16
3	Revise Dominant wavelength Measurement Allowance	2013/12/06
4	1. Add JEDEC Moisture Sensitivity 2. Add Reliability 3. Revise the name of Datasheet	2014/08/22
5	Update luminous intensity characteristic	2015/04/01
6	Update Luminous flux characteristic	2015/05/08

## About Edison Opto

Edison Opto is a leading manufacturer of high power LED and a solution provider experienced in LDMS. LDMS is an integrated program derived from the four essential technologies in LED lighting applications- Thermal Management, Electrical Scheme, Mechanical Refinement, Optical Optimization, to provide customer with various LED components and modules. More Information about the company and our products can be found at [www.edison-opto.com](http://www.edison-opto.com)

Copyright©2015 Edison Opto. All rights reserved. No part of publication may be reproduced or transmitted in any form or by any means, electronic or mechanical, including photo copy, recording or any other information storage and retrieval system, without prior permission in writing from the publisher. The information in this publication are subject to change without notice.

[www.edison-opto.com](http://www.edison-opto.com)

For general assistance please contact:  
[service@edison-opto.com.tw](mailto:service@edison-opto.com.tw)

For technical assistance please contact:  
[LED.Detective@edison-opto.com.tw](mailto:LED.Detective@edison-opto.com.tw)