

## Dong Feng Series DF-5C

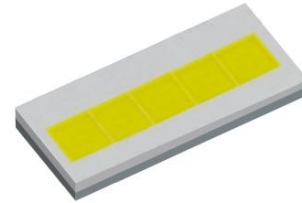

Dong Feng Headlamp series delivers unique brilliant light with outstanding efficiency and elegant design. It's able to meet requirements of output and stability due to its developed and tested to withstand extreme environment conditions and wide range of temperature change. It also provides distinct optical performance and uniform light pattern. With Dong Feng Headlamp series, you will start to experience and enjoy the excellent adventure during driving time.

### Features

- Excellent Brightness: 1850 lm@ 1A
- Color : According to ECE/SAE
- High Flux Density (Lux)
- With an Electrically Isolated Thermal Pad Structure

### Applications

- Exterior Automotive Lighting
- High Beam/ Low Beam for Headlight

## Ordering Information

$\frac{2}{X1}$        $\frac{D}{X2}$        $\frac{F5}{X3-X4}$        $\frac{25}{X5-X6}$        $\frac{CW}{X7-X8}$        $\frac{XX}{X9-X10}$        $\frac{DC5}{X11-X13}$        $\frac{XXX}{X14-X16}$

X1 Type		X2 Emitter Series		X3-X4 Emitter Series		X5-X6 Emitter Power		X7-X8 Emitting Color	
Code	Type	Code	Type	Code	Type	Code	Type	Code	Type
2	Emitter	D	Dong Feng	F5	5-Chip	25	25	CW	Cool White

X9-X10 Internal Code		X11-X13 PCB Board		X14-X16 Serial No.	
Code	Type	Code	Type	Code	Type
-	-	DC5	2.8x6.8	xxx	-

Package	Luminous Intensity, Iv [lm] If = 1000mA	Ordering Code
DF-5C	1850	2DF525CW06DC5002

## Maximum Ratings

Parameter	Symbol	Values	Unit
DC Forward Current ( $T_J = 25^\circ\text{C}$ )	$I_F$	1500	mA
Reverse Voltage <sup>[1]</sup>	$V_R$	Note1	V
LED Junction Temperature	$T_J$	150	$^\circ\text{C}$
Operating Temperature	$T_{opr}$	-40~+125	$^\circ\text{C}$
Storage Temperature	$T_{stg}$	-40~+125	$^\circ\text{C}$
HBM ESD Sensitivity	$V_B$	8000	V

**NOTE** LEDs are not designed to drive in reverse bias.

## Characteristics ( $T_J = 25^\circ\text{C}$ ; $I_F = 1000\text{mA}$ )

Parameter	Symbol	Values	Unit
Luminous Flux (typ.)	-	1850	lm
Thermal Resistance (typ.)	-	0.45	K/W
Viewing Angle (typ.)	$2\phi$	120	$^\circ$
Forward Voltage (typ.)	$V_F$	15	V

**NOTE**  $2\phi$  is the off-axis angle where the luminous intensity is half of the axial luminous intensity.

## Brightness Groups ( $T_J = 25\text{ }^\circ\text{C}$ ; $I_F = 1000\text{mA}$ )

Group	(min.) Luminous Intensity $I_v$ [lm]	(max.) Luminous Intensity $I_v$ [lm]
A0	1550	1800
B0	1800	2050
C0	2050	2300

**NOTE** 1. The luminous flux performance is guaranteed within published operating conditions.

2. Flux is measured with accuracy of  $\pm 10\%$

## Forward Voltage Groups ( $T_J = 25\text{ }^\circ\text{C}$ ; $I_F = 1000\text{mA}$ )

Group	(min.) $V_F$ [V]	(max.) $V_F$ [V]
X51	14.85	16.10
X52	16.10	17.35
X53	17.35	18.60

**NOTE** Forward voltage measurement allowance is  $\pm 0.08\text{V}$ .

**Chromaticity Coordinate Groups** ( $T_J = 25\text{ }^\circ\text{C}$ ;  $I_F = 100\text{mA}$ )

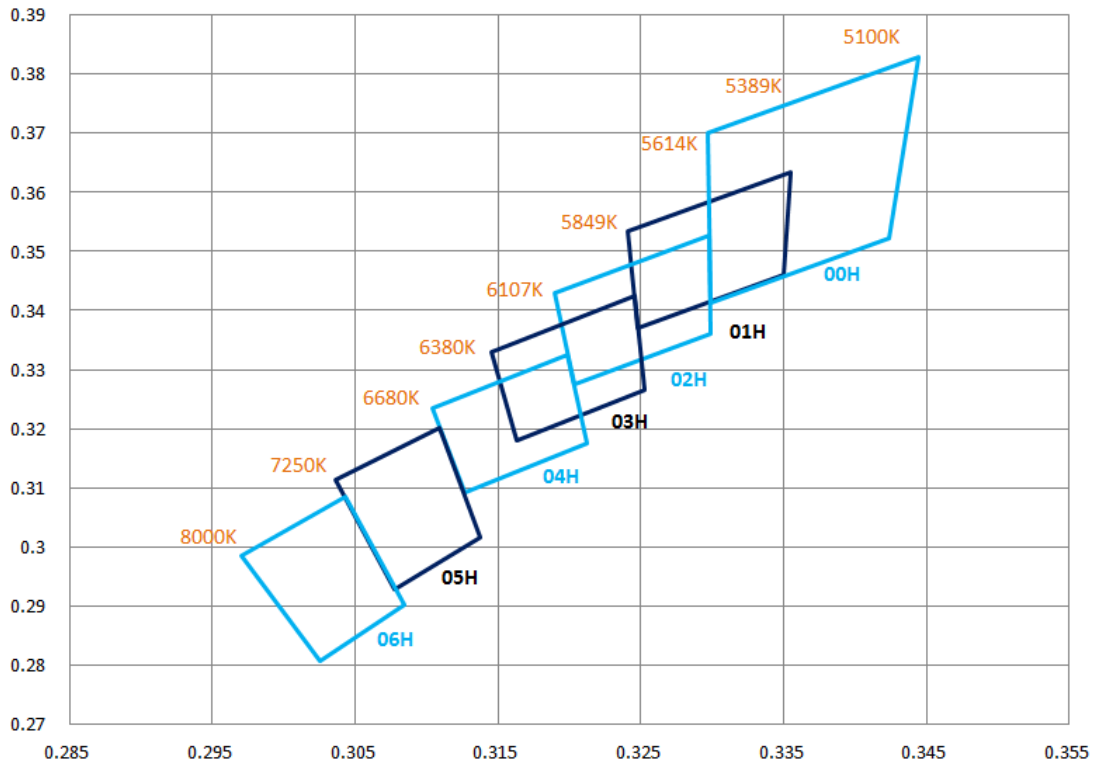

**Color Chromaticity Groups**

Group	Cx	Cy
00H	0.3297	0.3700
	0.3299	0.3414
	0.3424	0.3522
	0.3444	0.3828
01H	0.3241	0.3534
	0.3248	0.3370
	0.3350	0.3460
	0.3355	0.3633
02H	0.3190	0.3430
	0.3203	0.3274
	0.3298	0.3526
	0.3299	0.3361
03H	0.3145	0.3330
	0.3163	0.3181
	0.3246	0.3424
	0.3253	0.3266

Group	Cx	Cy
04H	0.3104	0.3234
	0.3127	0.3093
	0.3199	0.3325
	0.3212	0.3175
05H	0.3036	0.3114
	0.3078	0.2929
	0.3138	0.3017
	0.3109	0.3202
06H	0.2970	0.2985
	0.3025	0.2808
	0.3084	0.2902
	0.3043	0.3084

NOTE CIE\_x/y tolerance:  $\pm 0.005$

## Relative Spectral Emission

$I_{rel} = f(\lambda)$ ;  $T_J = 25^\circ\text{C}$ ;  $I_F = 1000\text{mA}$

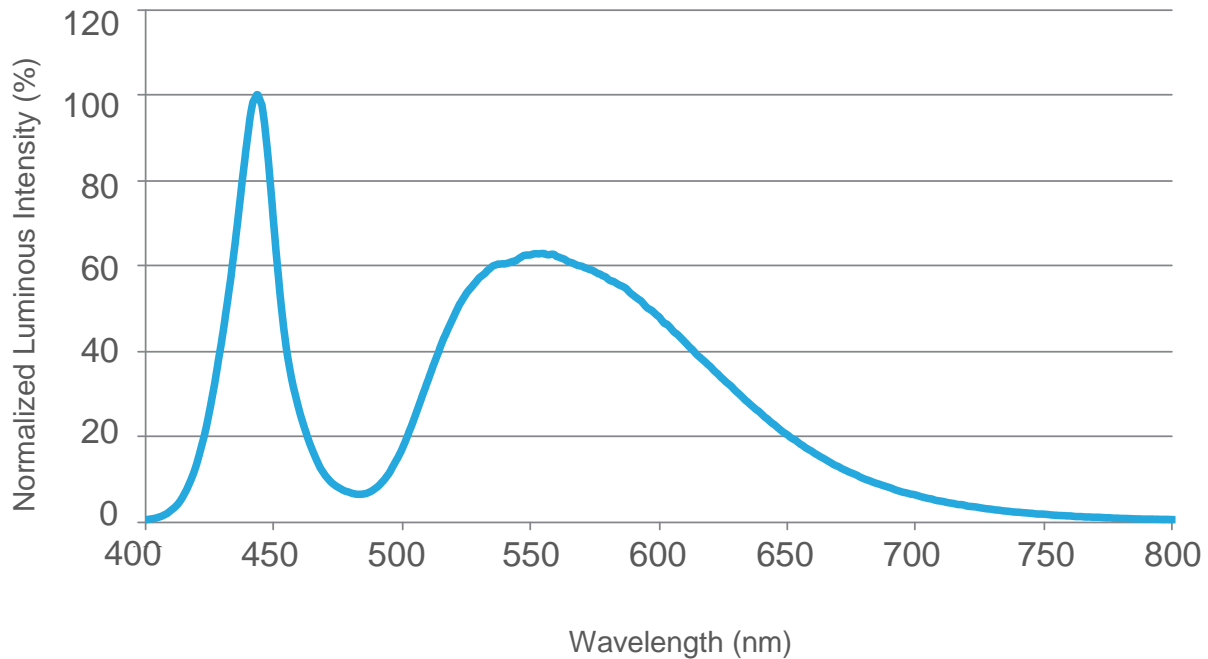

## Radiation Characteristics

$T_J = 25^\circ\text{C}$

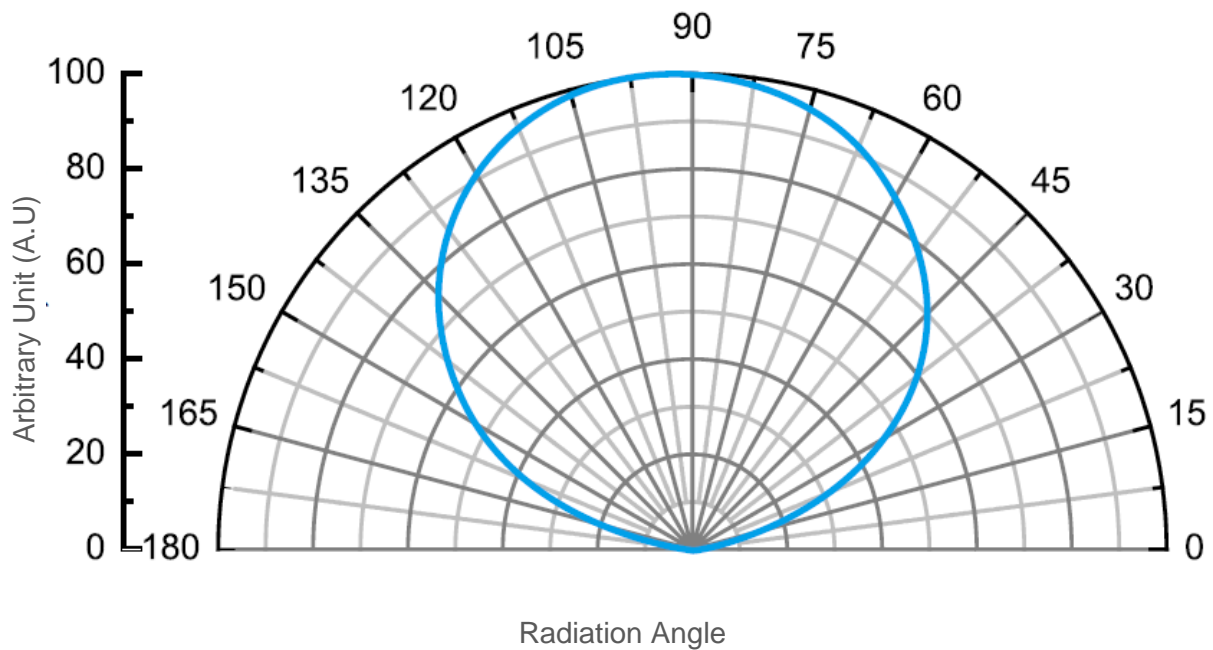

### Forward Current

$$I_F = f(V_F); T_J = 25^\circ\text{C}$$

$I_F$  [mA]

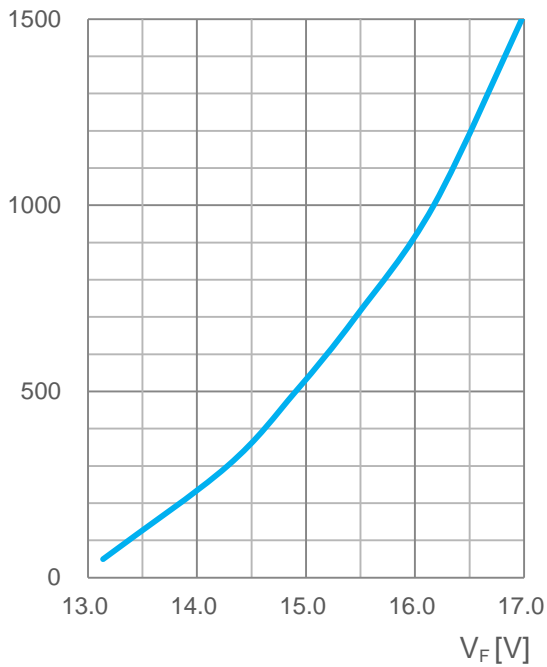

### Relative Luminous Intensity

$$\frac{IV}{IV(1000\text{mA})} = f(I_F); T_J = 25^\circ\text{C}$$

$\frac{IV}{IV(1000\text{mA})}$

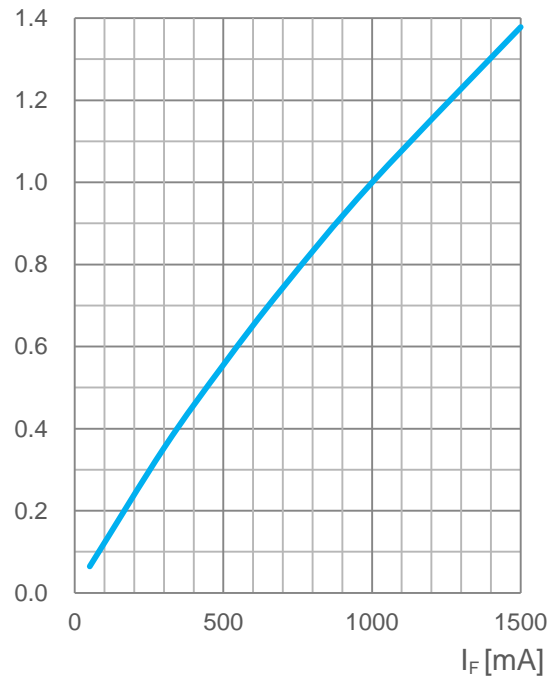

### Chromaticity Coordinate Shift

$$C_x, C_y = f(I_F); T_J = 25^\circ\text{C}$$

$C_x, C_y$

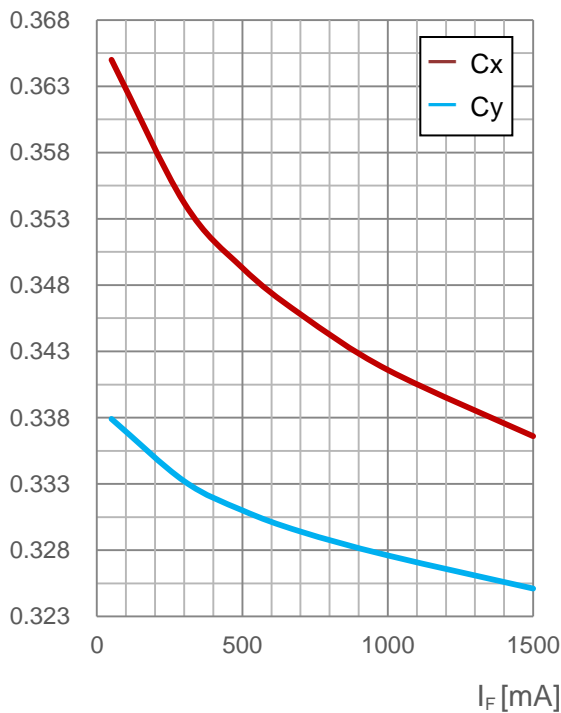

### Relative Forward Voltage

$\Delta V_F = V_F - V_F(25^\circ\text{C}) = f(T_J); I_F = 1000\text{mA}$   
 $\Delta V_F [\text{V}]$

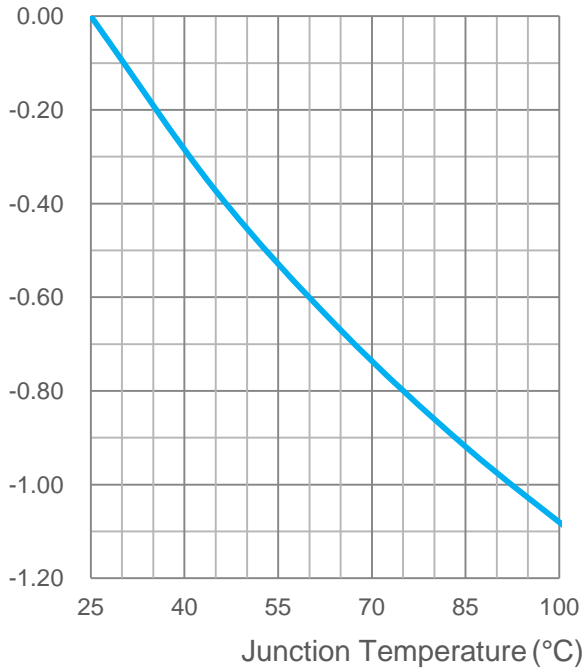

### Relative Luminous Intensity

$I_V / I_V(25^\circ\text{C}) = f(T_J); I_F = 1000\text{mA}$   
 $\frac{I_V}{I_V(25^\circ\text{C})}$

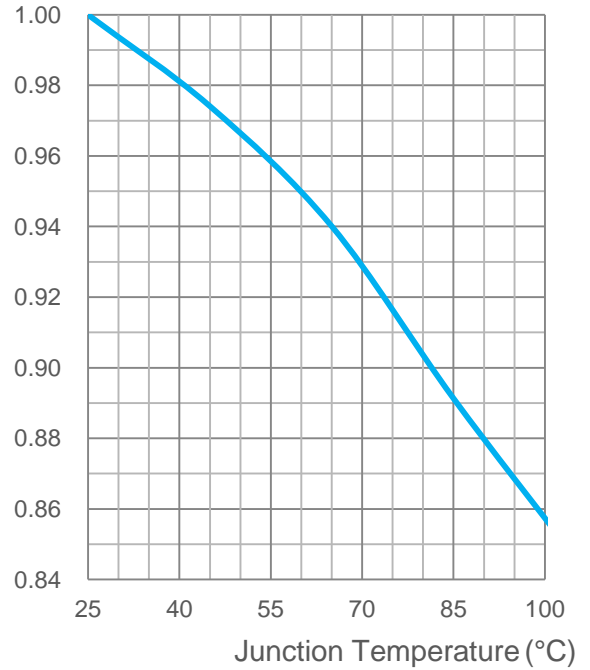

### Chromaticity Coordinate Shift

$C_x, C_y = f(T_J); I_F = 1000\text{mA}$

$C_x, C_y$

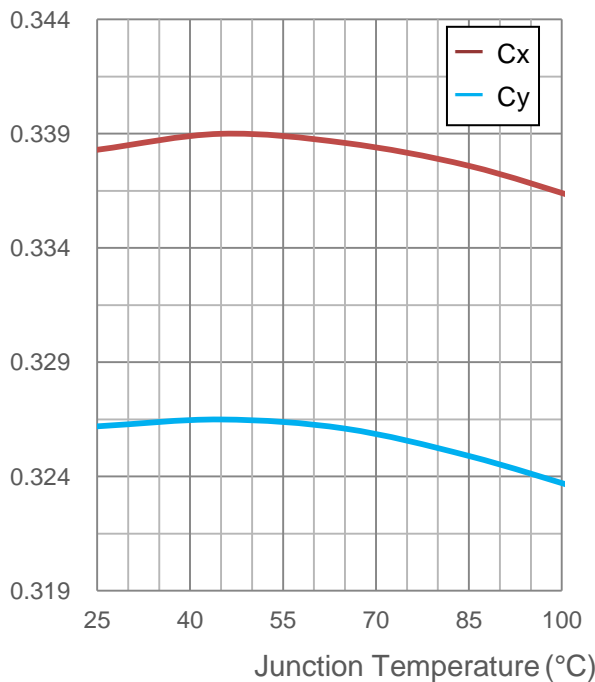



Mechanical Dimensions

Component

Note:

1. Unit: mm

2. Tolerance:  $\pm 0.10\text{mm}$

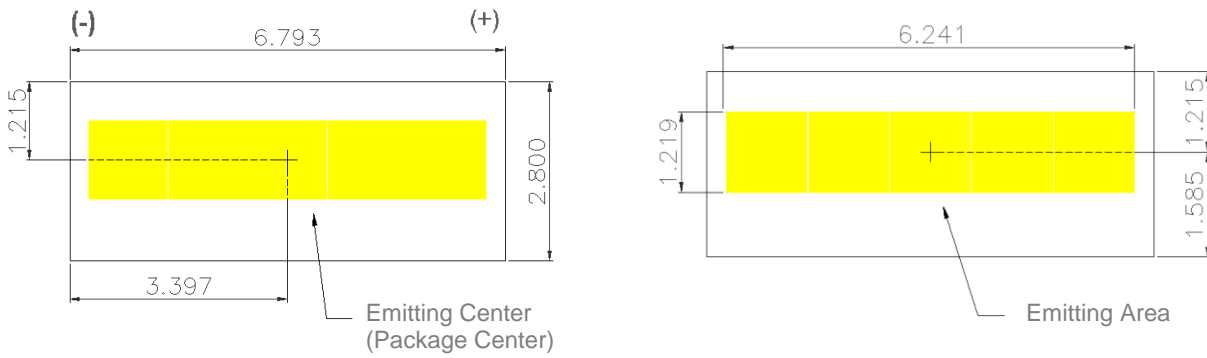

Top View

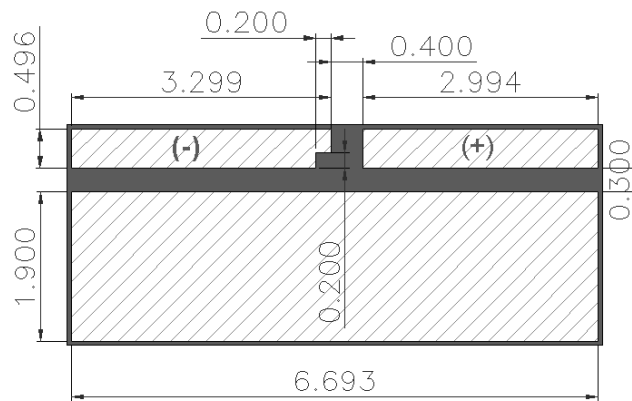

Bottom View (Pad)

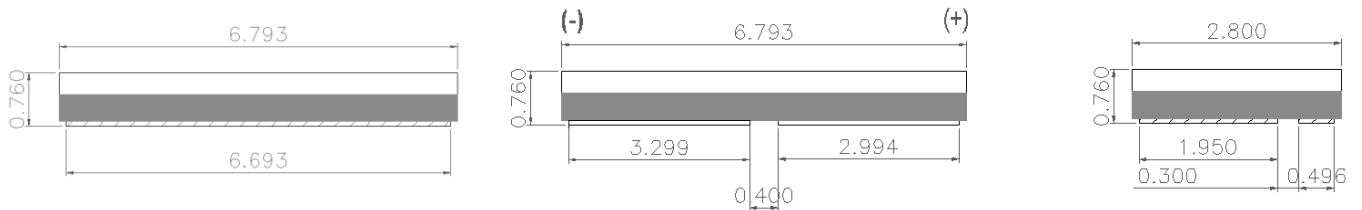

Side View

Circuit

Note:

1. Unit: mm

2. Tolerance:  $\pm 0.10\text{mm}$

Cathode(-)                      Anode(+)



Recommended PCB Solder Pad

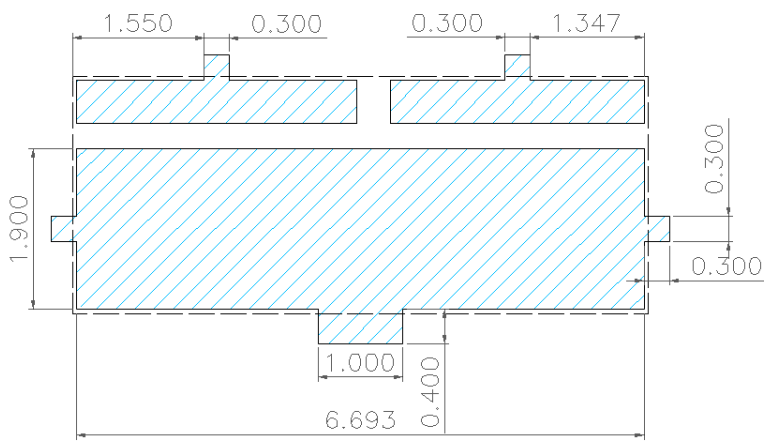

Recommended Stencil Mask

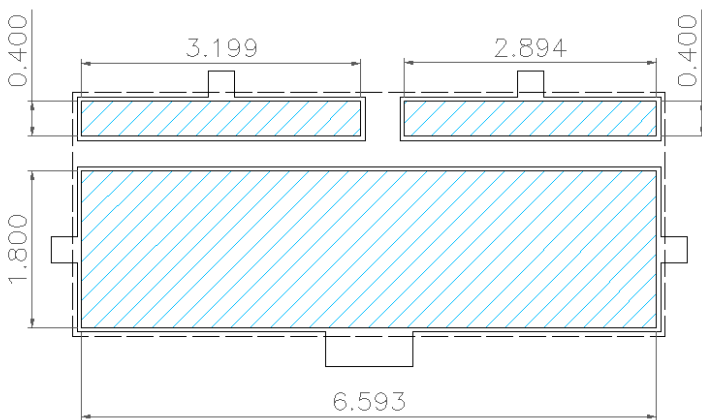

## Reflow Profile

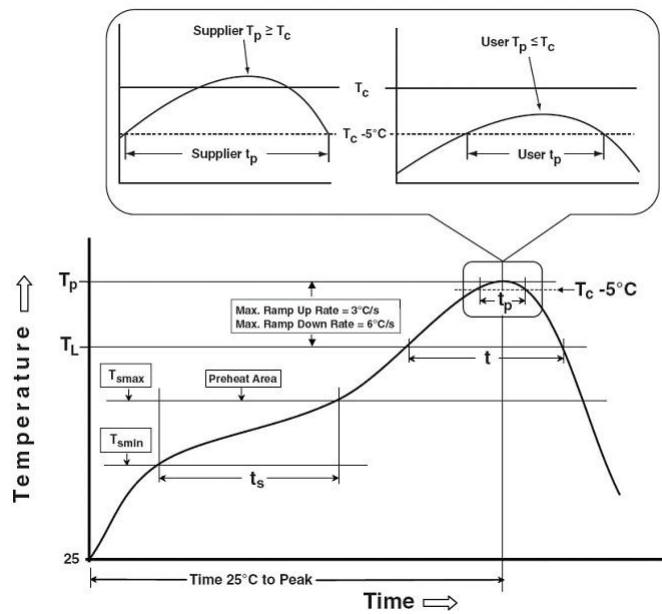

IPC-0204-6-1

Parameter	Symbol	Pb-Free (SnAgCu) Assembly			Unit
		Minimum	Recommendation	Maximum	
Preheat and Soak Temperature (T <sub>smin</sub> to T <sub>smax</sub> )	T <sub>s</sub>	150	150~200	200	°C /s
Time t <sub>s</sub> (T <sub>smin</sub> to T <sub>smax</sub> )	t <sub>s</sub>	60	-	120	S
Ramp-up Rate to Peak (T <sub>smax</sub> to T <sub>p</sub> )	-	-	-	3	°C /s
Liquidus Temperature	T <sub>L</sub>		217		°C
Time Above Liquidus Temperature	t <sub>L</sub>	60	-	150	s
Peak Temperature*	T <sub>p</sub>	255	-	260	°C
Time** Within 5°C of the Specified Classification Temperature	t <sub>p</sub>	-	30	-	s
Average Ramp-down Rate (T <sub>p</sub> to T <sub>smax</sub> )	-	-	-	6	°C /s
Time 25°C to Peak Temperature	-	-	-	8	min

NOTE 1.\* Tolerance for peak profile temperature (T<sub>p</sub>) is defined as a supplier minimum and a user maximum.

2.\*\* Tolerance for time at peak profile temperature (t<sub>p</sub>) is defined as a supplier minimum and a user maximum.

3. Maximum temperature of SMT process must be under 300°C, and the duration at 300°C must be within 10 seconds.

## Pick and Place

- Dong Feng series is compatible for all kind of SMT instrument.
- Using the recommended nozzle design can be more accurate during the SMT process.

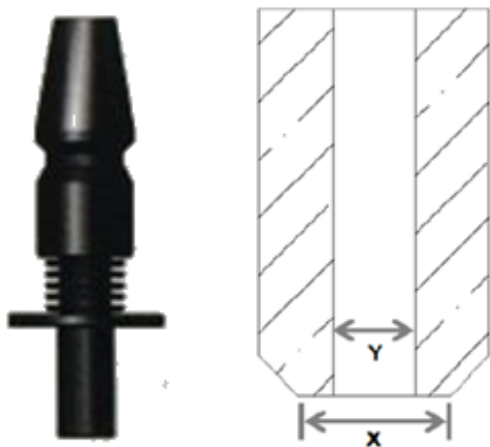

### Recommended Nozzle Specification

Parameter	Spec.
Outside Diameter(x)	Ø 2.2
Inside Diameter(y)	Ø 1.4
Material	Ceramic

## Product Packaging Information

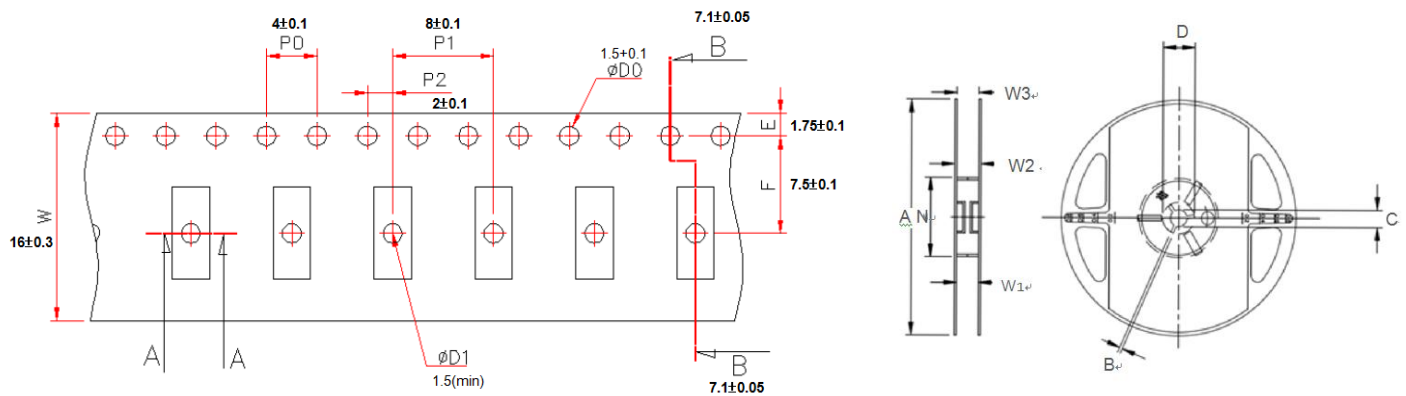

### Tape Dimensions

W	E	F	P0	P1	P2	D0	D1	B
$16 \pm 0.3$	$1.75 \pm 0.1$	$7.5 \pm 0.1$	$4.0 \pm 0.1$	$8.0 \pm 0.1$	$2 \pm 0.1$	$1.5 \pm 0.1/-0$	$1.5(\text{min})$	$7.1 \pm 0.05$

### Reel Dimensions

A	N	W1	W2	W3	D	B	C
$178 \pm 1.0$	$60 \pm 0.5$	$17 \pm 0.5/-0$	$20 \pm 0.5$	$> 16$	$21.3 \pm 0.2$	$2.3 \pm 0.2$	$13.5 \pm 0.2$

Unit: mm  
 16 mm tape with 1500 PCS on  $\Phi 178$  mm reel

## Thermal Management

A high temperature operation condition always easily causes the decrease of flux and the decay of LED dies. The highest operation temperature of a component is able to be found by the indication of junction temperature in its datasheet. The power dissipation ability, the ambient temperature of LED junction, environment, thermal path and its thermal resistance are the main parameters which affect the performance of a LED device. Therefore, the limitation of junction temperature has become an important issue when designing a LED product.

The following paragraphs describe how to determine the junction temperature and a simple ideal to heat sink design. Thermal resistance is the temperature difference across a structure when a unit of heat energy flows through in unit time. For LEDs, temperature difference presents the temperature between a die's PN junction and package substrate. For the same package structure and operating condition, the smaller thermal resistance a LED has, the lower temperature of this LED. With lower operation temperature, a LED would keep its original performance for longer. By estimating the PN junction temperature, users may be aware that the thermal management had been well designed.

From basic thermal equation for thermal resistance :  $R_{th(J-A)} = \frac{\Delta T_{(J-A)}}{P_D}$

Therefore the junction temperature ( $T_J$ ) is :  $T_J = T_A + R_{th(J-A)} \times P_D$

which,

$P_D$  : Power Dissipation = Forward Voltage ( $V_F$ ) x Forward Current ( $I_F$ )

$T_A$  : Ambient Temperature (assume 25°C)

$R_{th(J-A)}$  : Total Thermal Resistance =  $R_{th(J-S)} + R_{th(S-B)} + R_{th(B-A)}$

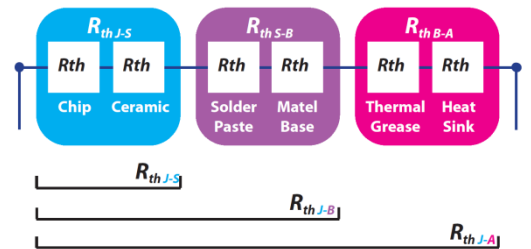

The temperature of phosphor surface must be well-controlled under 150°C



SMT total void has to be controlled under 10%. (Must have 100% X-ray by self-inspection or SMT manufacturer.)

**Thermal Grease**  
K(W/m · K)>2 is better for heat conduction with uniformly applied.

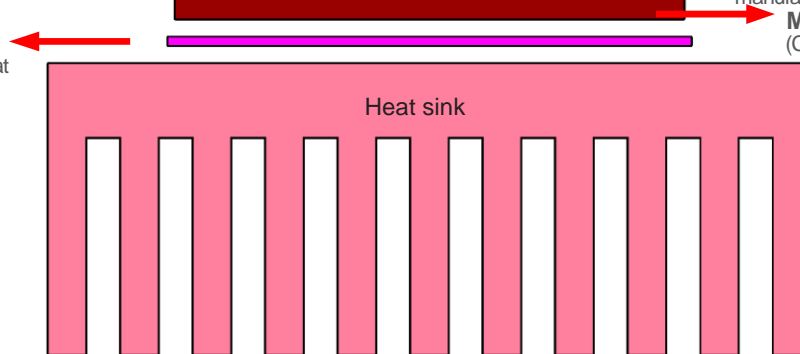

## Tips for Thermal Management

Dong Feng products (e.g: 25W) are not recommended to be operating without a heat sink. Through MCPCB, users may realize better performance.

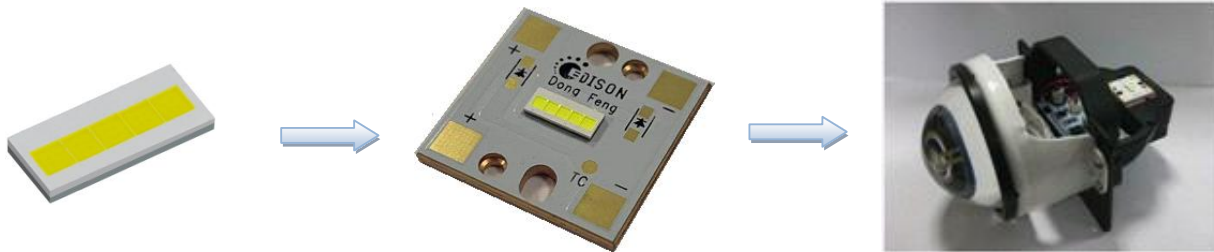

For LEDs, choose an appropriate operation environment and conduct the heat to the air after light on LEDs may maintain the better performance and lifetime. Four major thermal path are as follow:

- From heat source (component) to heat sink. (By conduction)
- Conduction within the heat sink to its surface. (By conduction)
- Transfer from the surface to the surrounding air. (By convection)
- Emit heat from the heat sink surface. (By Radiation)

Path1 : The contact surface of the MCPCB and heat sink are not perfectly flat, they are not able to meet each other completely. Air between these two materials will result in high thermal resistance and reduce the effect of heat transfer. To enhance the ability of thermal conduction, one common method is applying thermal grease between the two interfaces and uses the screws to enforce the adhesion between two surfaces.

Path2 : Temperature gradient depends on the time of a heat sink. The total heat flux(Q) consists of:

1. The temperature difference between heat source ( $T_J$ ) and heat sink ( $T_H$ )
2. Thermal Conductivity (K) of the heat sink
3. Total surface area of the heat sink (A)
4. The linear path distance of the heat transfer (L)

This is represented by the Fourier's Law as follow:

$$Q = K \times A \times \frac{\Delta T}{L}$$

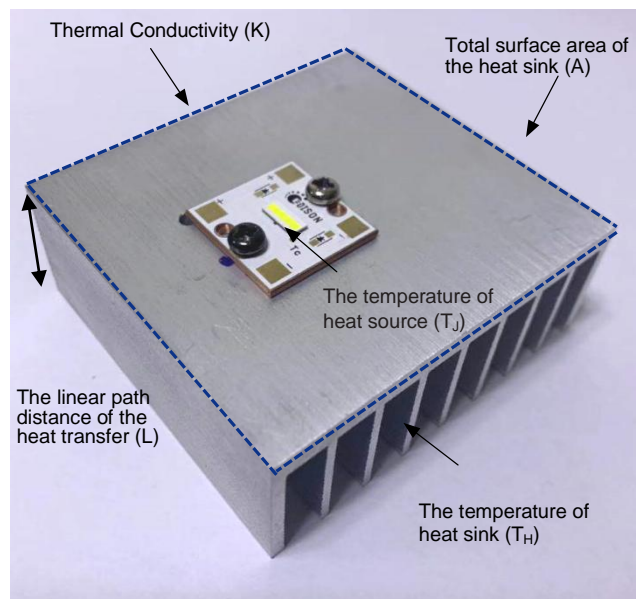

By choosing a higher thermal conductivity, increasing the surface area of the heat sink (add the number of fins) or shorten the distance of the linear path of heat dissipation may improve the loss of heat flux per unit time. Among all materials, metal is the best choice because of its high thermal conductivity.

**List of thermal conductivity for some usual materials**

Material	K(W/m·K)
Copper	391
C1100	384
Aluminum	230
5000 Series	225
ADC-12	96.2
Magnesium	156
Air	0.024

Path3 : Heat dissipation includes convection and radiation. Those two types of transfer are proportional to the surface area of the heat sink. Adding the number of fin may increase the total surface area. However, too many fins may cause inhabitation of convection. There are many other thermal management methods such as install a fan to reach obliged convection. But this design may cause the issues such as noise or circuit design problem.

Path4 : Compare with an unfinished heat sink, the one that covered by high emissivity material, such as ceramic powder or deep color paint, usually has better radiation ability. Both anodizing and etching are also effective to increase the thermal dissipation.

Key points for thermal management:

- The contact surface’s flatness and smoothness of the component and heat sink.
- The total surface area of heat sink.
- The selection of heat sink material.
- Optimum number of fins. (Aerodynamic optimization)



## Recommended PCB Design

The PCB design can affect the thermal performance of the end product. In order to reduce the thermal resistance of PCB, heat must transfer through metal without dielectric layer. The figure below shows the cross-section of PCB.

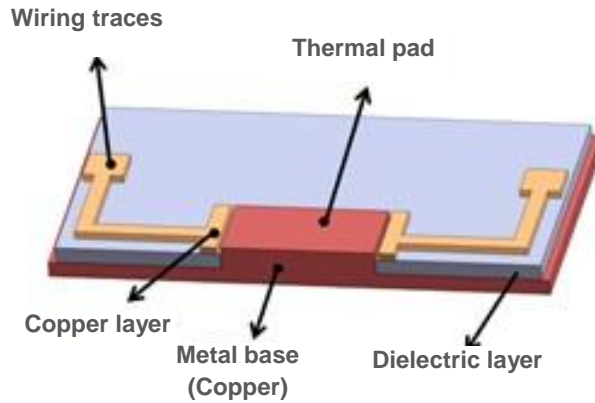

## Handling Manual

Dong Feng Series LED use phosphor film on the emitting surface, sealing by silicon. LED may be deformed or destructed if excessive force is applied.

When manually handling the LED, please use the plastic tweezers instead of the metal one. Avoid contacting to the white silicon structure which will cause damage to the package.

- Plastic Tweezers

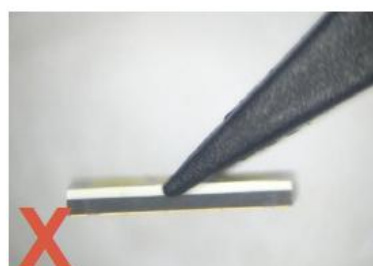
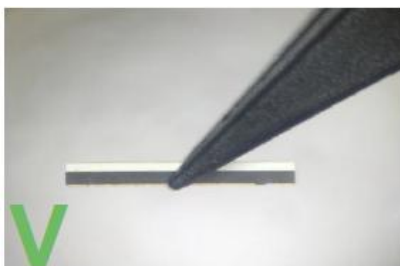

- Metal Tweezers

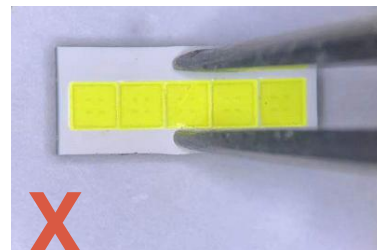
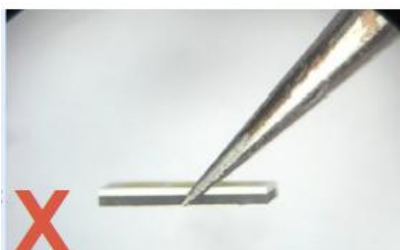

**EU RoHS and China RoHS compliants product**

符合歐盟 RoHS 指令的要求；

中國的相關法規和標準，不含有毒有害物質或元素。

