

2T15X5PA00035SA1

Ultra high reliability and luminous efficacy ,PLCC LED Series are optimized to be used as lighting for automotive signal lighting designs or signboard.

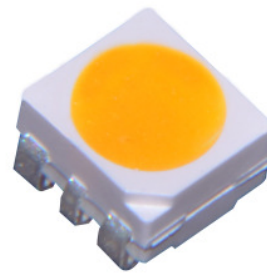

Automotive
Lighting

Applications :

- Automotive Interior/Exterior Lighting

Features :

- Package: Ag Plated 6 pad design package with silicone resin
- Dimension: 3.4 mmx3.3 mm
- Chip technology: InGaN
- View Angle: 120°
- Color : PC Amber
- ESD: 2 kV acc. to ANSI/ESDA/JEDEC JS-001 (HBM, Class 2)
- MSL: Level 2
- Qualifications: The product qualification test based on the guidelines of AEC-Q102

Table of Contents

General Information	3
Absolute Maximum Ratings	4
Characteristics	4
Luminous Flux Characteristic.....	5
Voltage Bin Structure	5
Color BIN code.....	6
Characteristic Curves	7
Mechanical Dimensions.....	11
Reflow Profile	13
Product Packaging Information.....	14
Cautions.....	15
Revision History	16
About Edison Opto	16

General Information

Ordering Code Format

2 T 15 X5 PA 00 03 5 S A 1
 X1 X2 X3-X4 X5-X6 X7-X8 X9-X10 X11-X12 X13 X14 X15 X16

X1	X2		X3-X4		X5-X6		X7-X8	
Type	Component		Series		Wattage		Color/CCT	
2	Emitter	T	PLCC	15	3433	X5	0.5W	PA PC Amber

X9-X10		X11-X12		X13		X14		X15	
CRI(Ra)		Voltage		Leadframe Mode		Leadframe Plating		Model	
00	-	03	3V	5	PCT 1.90H 6PIN	S	Silver	A	Automotive

X16	
Serial Number	
-	-

Absolute Maximum Ratings

Absolute maximum ratings

Parameter		Symbol	Values
Operating Temperature	min.	T_{op}	-40 °C
	max.		110 °C
Storage Temperature	min.	T_{stg}	-40 °C
	max.		110 °C
Junction Temperature	max.	T_j	125 °C
Forward current $T_j = 25\text{ °C}$	min.	I_F	5 mA
	max.		200 mA
Surge Current $t \leq 10\ \mu\text{s}; D = 0.005; T_j = 25\text{ °C}$	max.	I_{FS}	300 mA
Reverse voltage $T_j = 25\text{ °C}$	max.	V_R	Not designed for reverse operation
ESD withstand voltage acc. to ANSI/ESDA/JEDEC JS-001 (HBM, Class 2)		V_{ESD}	2 kV

Notes: Proper current derating must be observed to maintain junction temperature below the maximum at all time.

Characteristics

$I_F = 140\text{ mA}; T_j = 25\text{ °C}$

Parameter		Symbol	Values
Viewing angle	typ.	φ	120 °
Forward Voltage	min.	V_F	2.70 V
	typ.		3.05 V
	max.		3.30 V
Reverse current $V_R = 5\text{ V}$	typ.	I_R	0.01 μA
	max.		10 μA
Real thermal resistance junction/solder point	typ.	$R_{thJS\ real}$	42 K / W
	max.		50 K / W
Electrical thermal resistance junction/ solder point with efficiency $\eta_e = 27\%$	typ.	$R_{thJS\ elec.}$	30 K / W
	max.		36 K / W

Luminous Flux Characteristic

Luminous Flux Characteristics, $I_f=140\text{mA}$, $T_j=25^\circ\text{C}$

Symbol	Group	Min. Luminous Flux(lm)	Max. Luminous Flux(lm)	Typ. Luminous Intensity(cd)
Iv	35	35	40	11.7
	40	40	45	13.3
	45	45	50	14.8

Note:

The luminous flux performance is guaranteed within published operating conditions. Edison Opto maintains a tolerance of $\pm 10\%$ on flux measurements.

Voltage Bin Structure

Voltage Bin Structure, $I_f=140\text{mA}$, $T_j=25^\circ\text{C}$

Symbol	Group	Min. Voltage (V)	Max. Voltage (V)
V _F	B70	2.70	2.90
	B90	2.90	3.10
	C10	3.10	3.30

Note:

Forward voltage measurement allowance is $\pm 0.1\text{V}$.

Color BIN code

PC Amber CIE

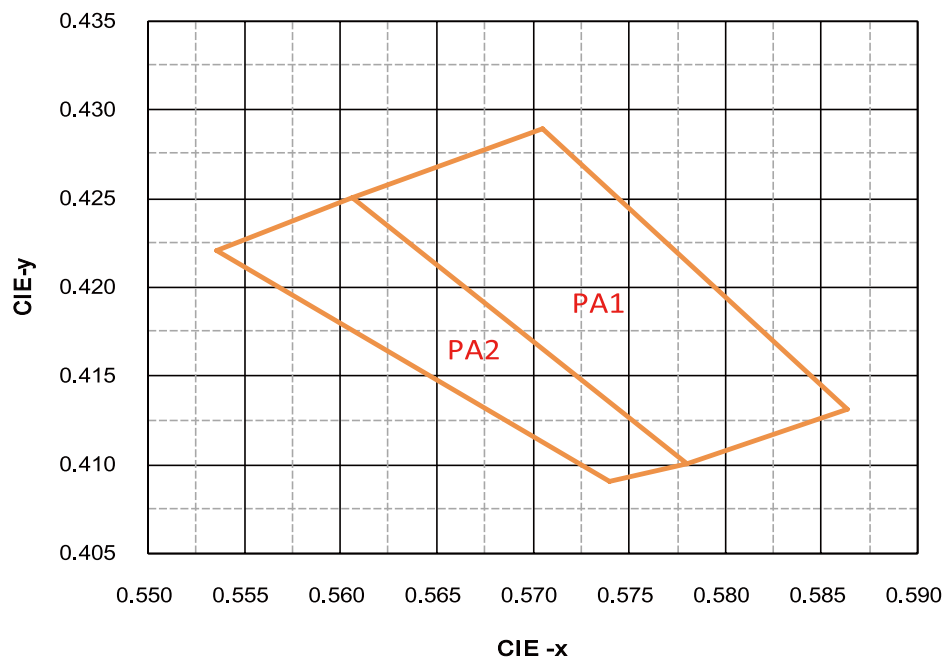

Color Bin	X	Y	Color Bin	X	Y
PA1	0.5606	0.4250	PA2	0.5536	0.4221
	0.5705	0.4289		0.5606	0.4250
	0.5863	0.4131		0.5780	0.4100
	0.5780	0.4100		0.5740	0.4090

Notes:

1. PLCC 3433 PC Amber Emitters are tested and binned by x,y coordinates.
2. Edison maintains a tester tolerance of ± 0.005 on x, y color coordinates.

Characteristic Curves

Color Spectrum

$I_f = 140 \text{ mA}$; $T_j = 25 \text{ }^\circ\text{C}$

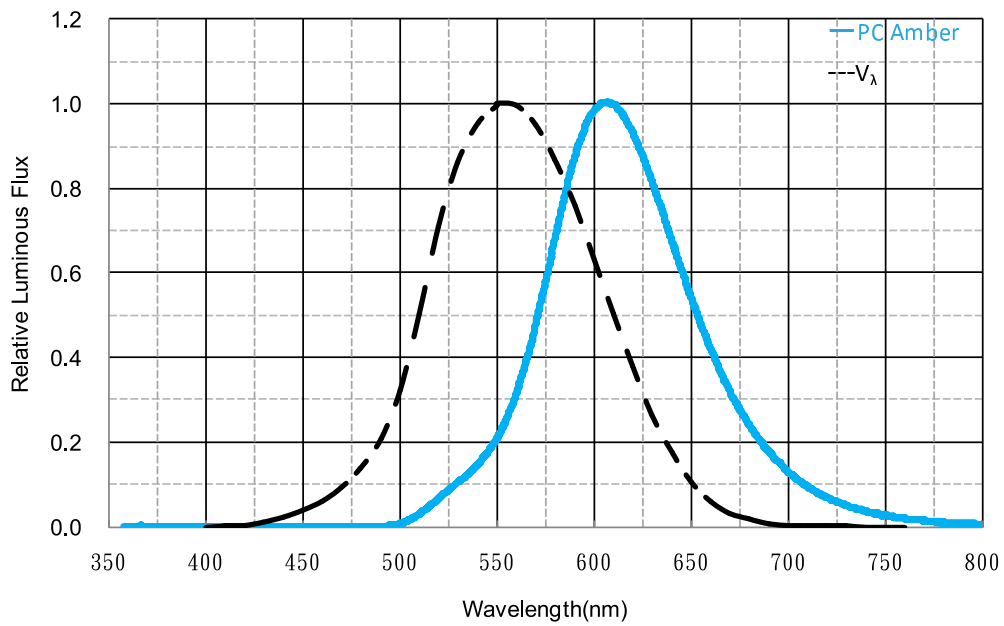

Beam Pattern

$I_f = 140 \text{ mA}$; $T_j = 25 \text{ }^\circ\text{C}$

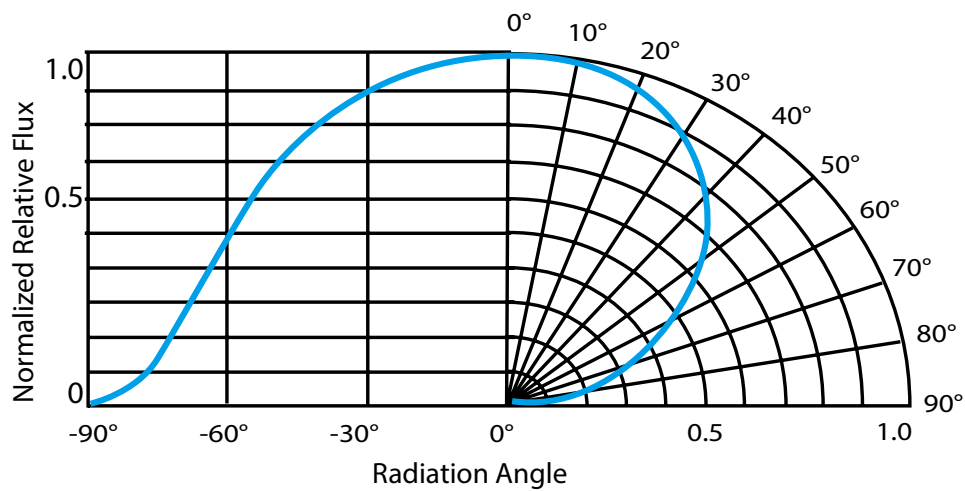

Relative Forward Voltage

$$V_F/V_F(140 \text{ mA}) = f(V_F); T_J = 25^\circ\text{C}$$

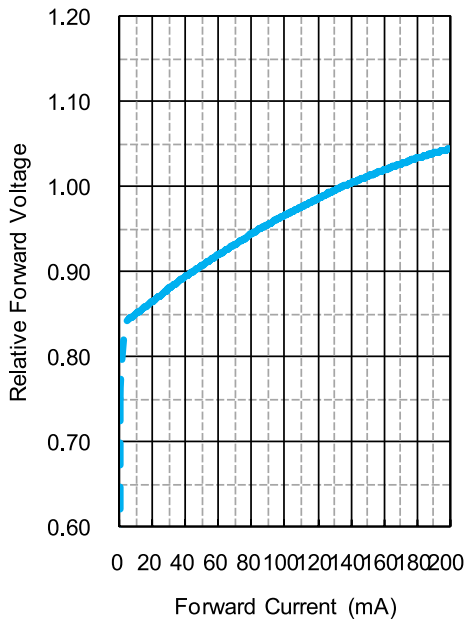

Relative Luminous Flux

$$I_v/I_v(140 \text{ mA}) = f(I_v); T_J = 25^\circ\text{C}$$

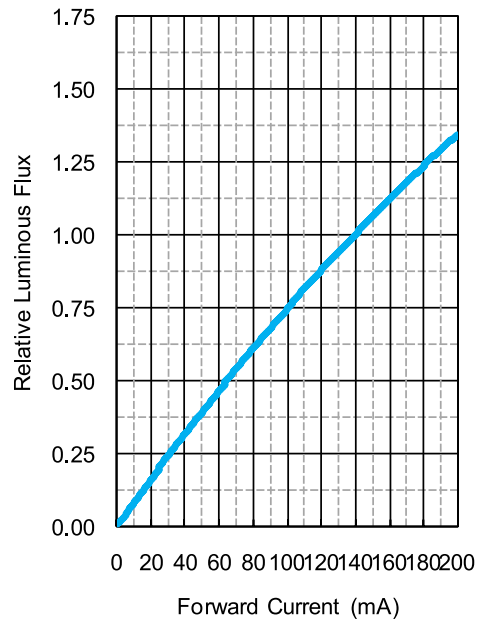

Chromaticity Coordinate Shift

$$\Delta C_x, \Delta C_y = f(I_F); T_J = 25^\circ\text{C}$$

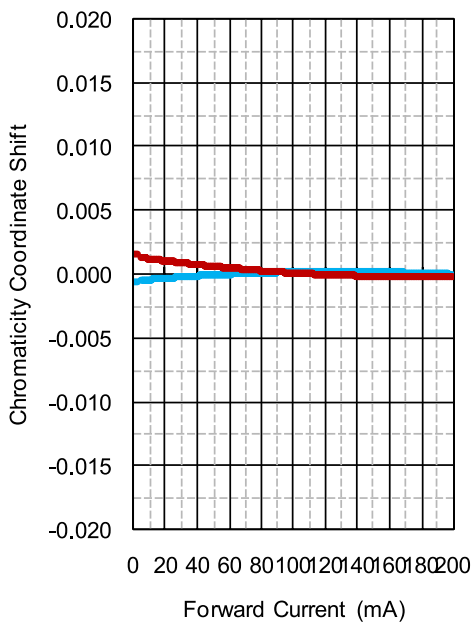

Relative Forward Voltage

$$V_F/V_F(25^\circ\text{C}) = f(V_F); I_F = 140\text{ mA}$$

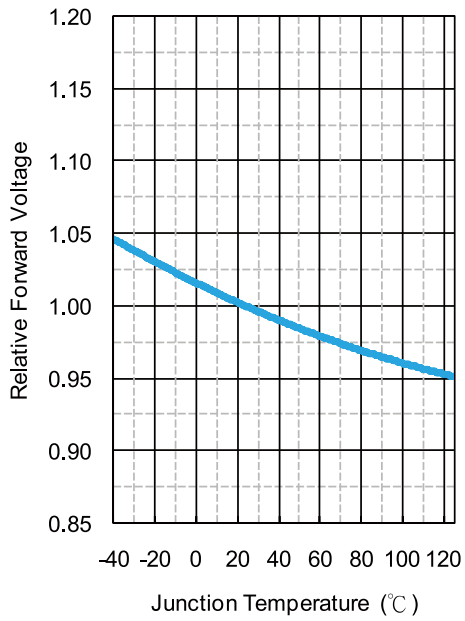

Relative Luminous Flux

$$I_v/I_v(25^\circ\text{C}) = f(I_v); I_F = 140\text{ mA}$$

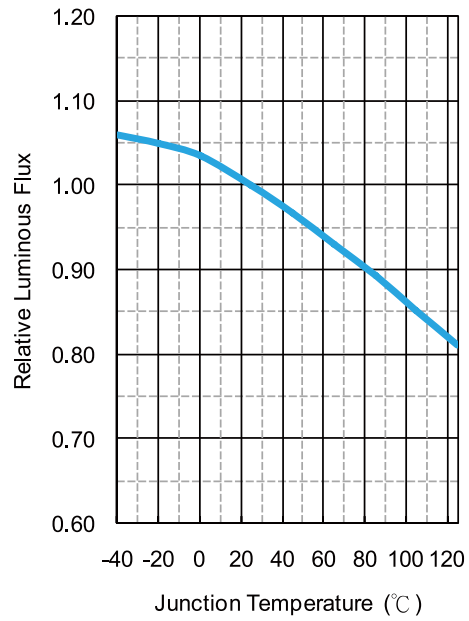

Chromaticity Coordinate Shift

$$\Delta C_x, \Delta C_y = f(T_j); I_F = 140\text{ mA}$$

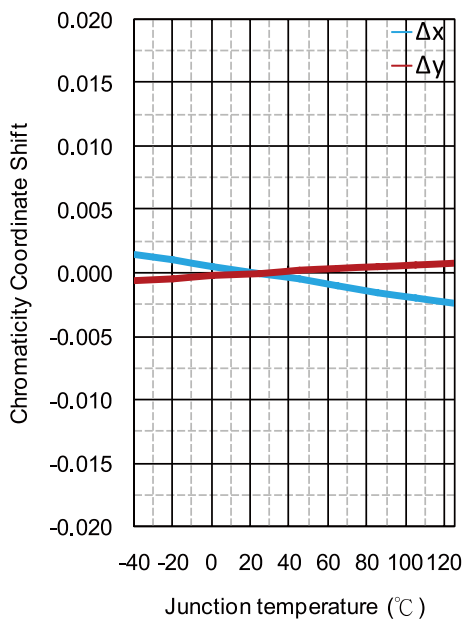

Max. Permissible Forward Current

$$I_f = f(T)$$

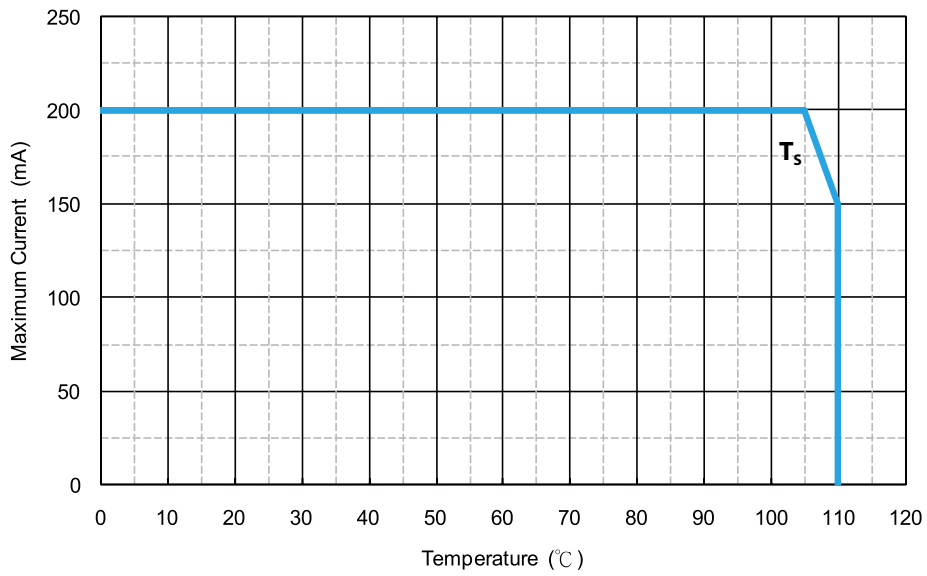

Mechanical Dimensions

Dimensional Drawing

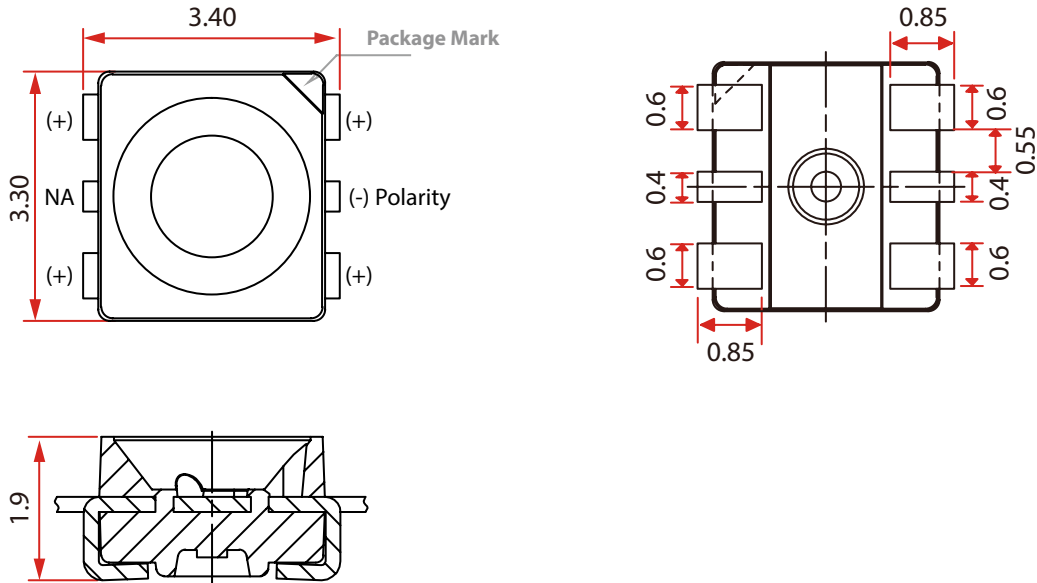

Circuit

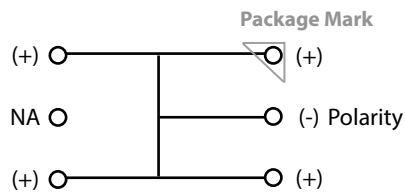

Notes:

1. All dimensions are measured in mm.
2. Tolerance : ± 0.1 mm
3. Approximate Weight : 38.0 mg

Recommended Solder Pad

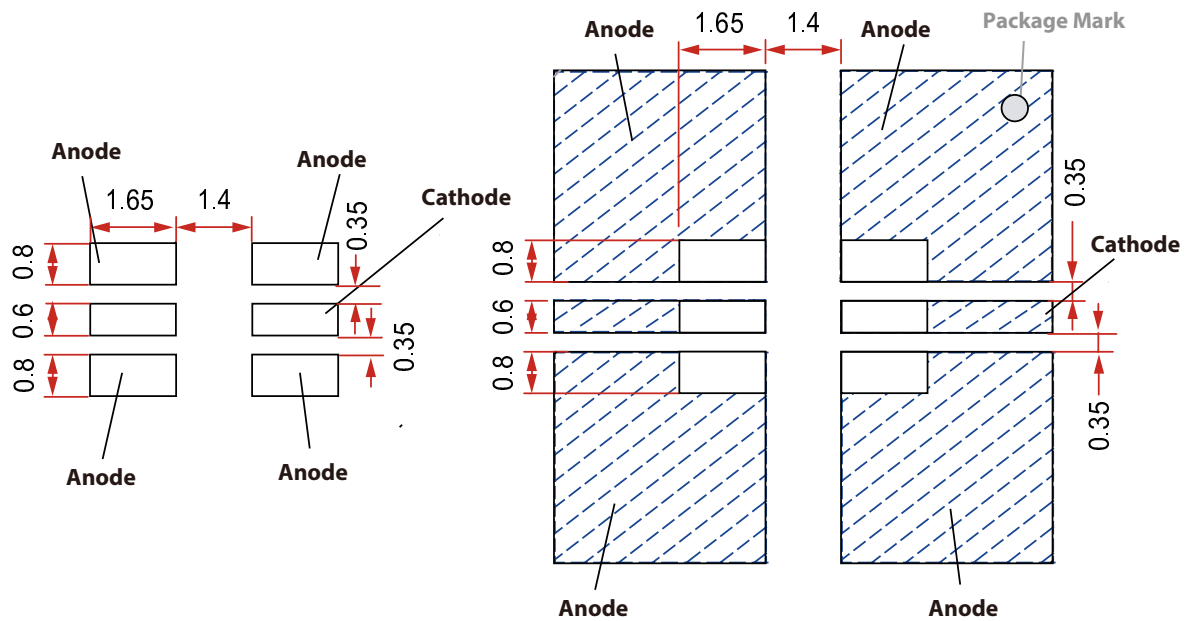

Pad design for improved heat dissipation

 Solder resist

Notes:

1. All dimensions are measured in mm.
2. Tolerance : ± 0.1 mm

Reflow Profile

The following reflow profile is from IPC/JEDEC J-STD-020D which provided here for reference.

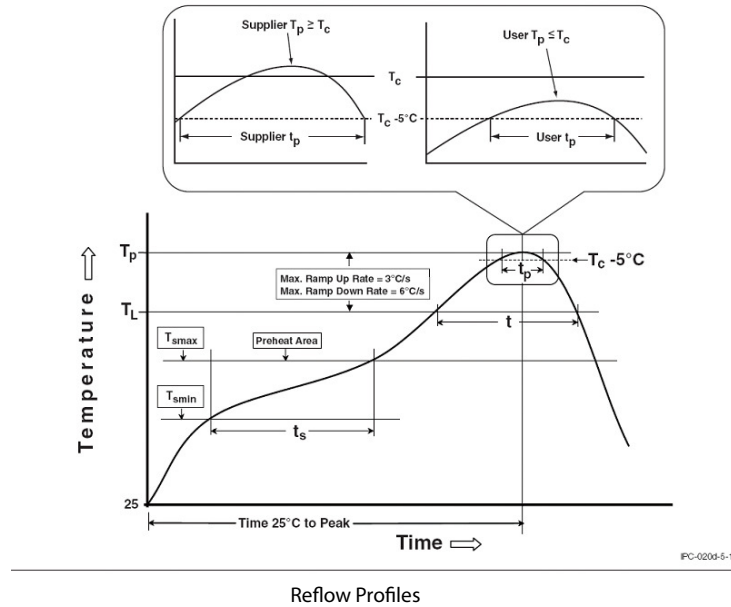

Classification Reflow Profiles

Profile Feature	Pb-Free Assembly
Preheat & Soak Temperature min (T_{smin}) Temperature max (T_{smax}) Time (T_{smin} to T_{smax}) (t_s)	150 °C 200 °C 60-120 seconds
Average ramp-up rate (T_{smax} to T_p)	3 °C/second max.
Liquidous temperature (T_L) Time at liquidous (t_L)	217 °C 60-150 seconds
Peak package body temperature (T_p)	255 °C ~260 °C
Classification temperature (T_c)	260 °C
Time (t_p) within 5 °C of the specified classification temperature (T_c)	30 seconds
Average ramp-down rate (T_p to T_{smax})	6°C/second max.
Time 25°C to peak temperature	8 minutes max.

Product Packaging Information

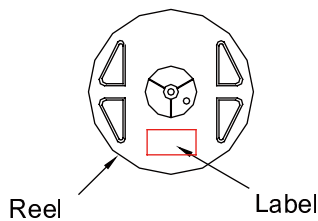
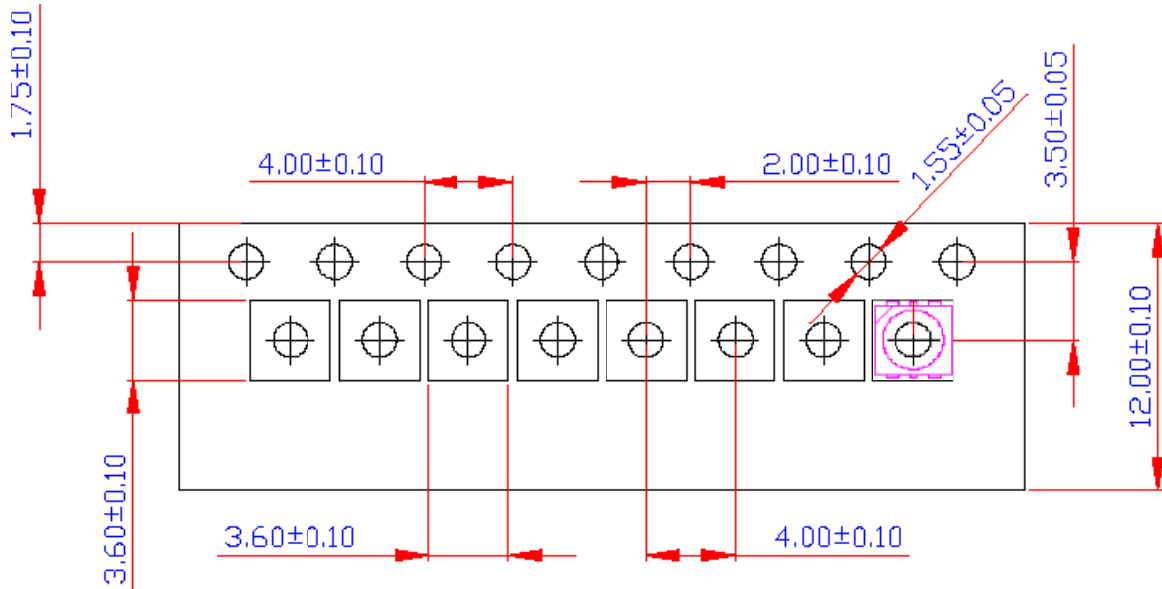

Taping reel dimensions

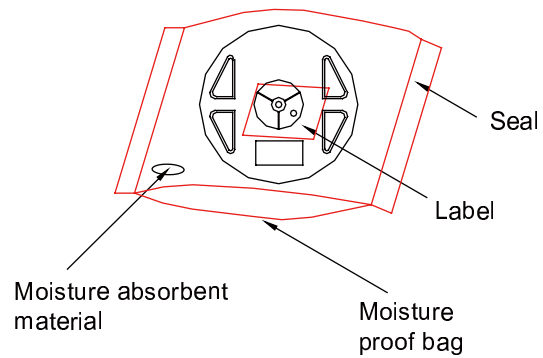

Package & label

Item	Quantity	Total	Dimensions(mm)
Reel	600pcs	600pcs	R=178
Starting with 200pcs empty, and 150pcs empty at the last			

Cautions

- (1) Moisture monitoring is vital during the storage of LEDs for if too much moisture is absorbed, interface delamination and optical performance degradation will occur. Therefore, products should be packed in moisture-proof aluminum bags so as to reduce moisture absorption to the lowest degree during transportation and storage. Included moisture-proof aluminum bag are the key indicators that they will change from brown to azure if bags are invaded by moisture.
- (2) Soldering process in compliance with the range of the conditions stated above should be conducted after opening the moisture-proof aluminum bag. The rest LEDs should be stored in a hermetically sealed container, silica gel desiccants included. And the original moisture-proof aluminum bags are recommended.
- (3) If the "Period After Opening" storage time is too long or silica gel desiccants don't maintain blue any more, baking process should be done once.

Revision History

Versions	Description	Release Date
1	Establish a Datasheet	2020/04/14

About Edison Opto

Edison Opto is a leading manufacturer of high power LED and a solution provider experienced in LDMS. LDMS is an integrated program derived from the four essential technologies in LED lighting applications- Thermal Management, Electrical Scheme, Mechanical Refinement, Optical Optimization, to provide customer with various LED components and modules. More Information about the company and our products can be found at www.edison-opto.com

Copyright©2020 Edison Opto. All rights reserved. No part of publication may be reproduced or transmitted in any form or by any means, electronic or mechanical, including photo copy, recording or any other information storage and retrieval system, without prior permission in writing from the publisher. The information in this publication are subject to change without notice.

www.edison-opto.com

For general assistance please contact:
service@edison-opto.com.tw

For technical assistance please contact:
LED.Detective@edison-opto.com.tw